

PROTOTYPE

1

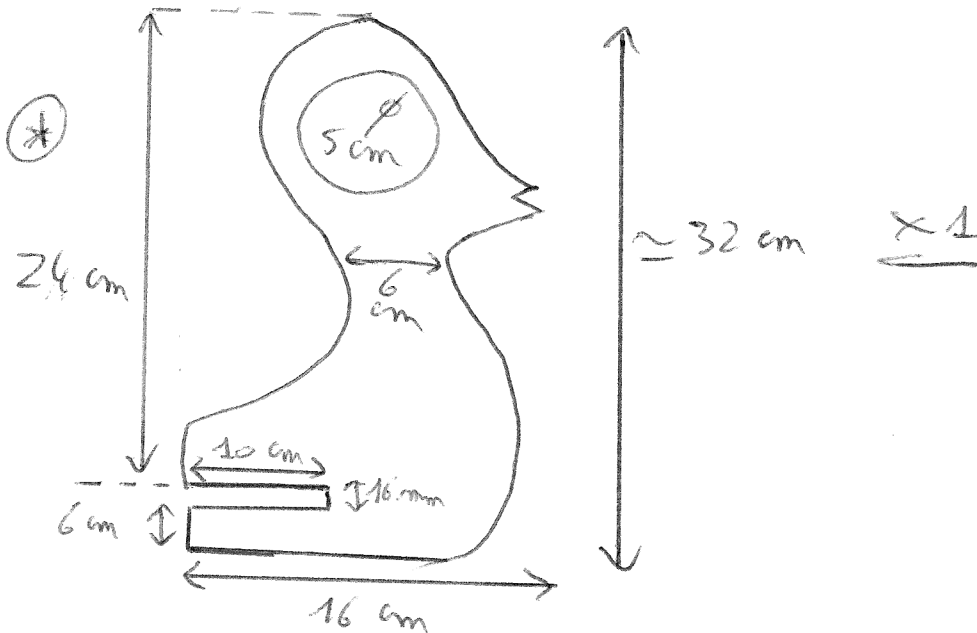

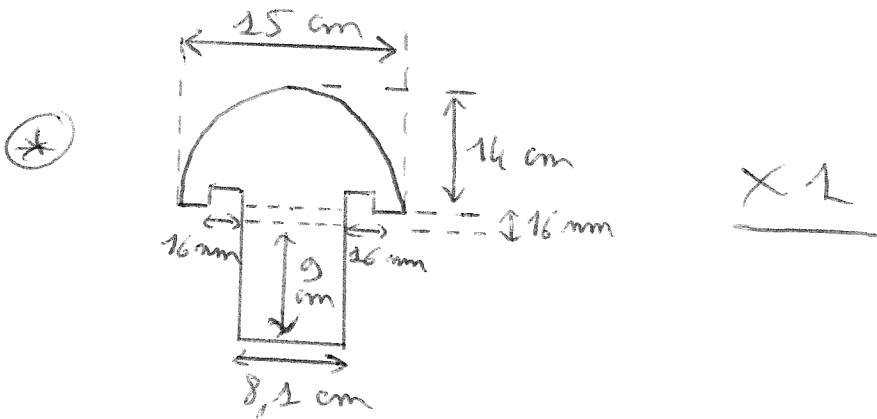
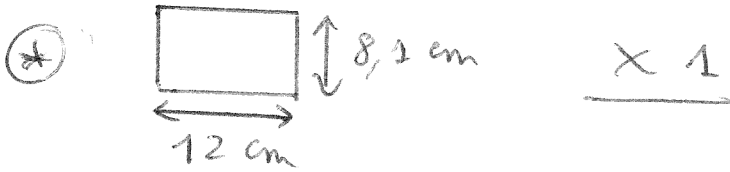
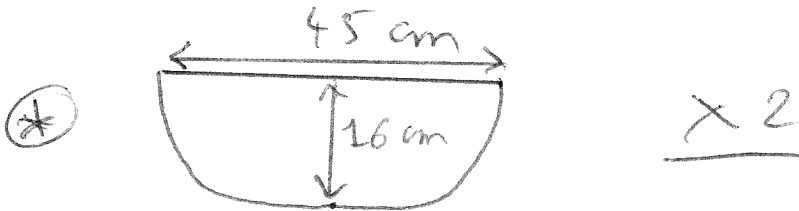
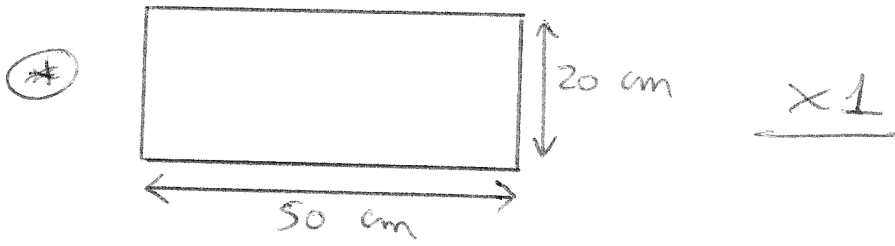
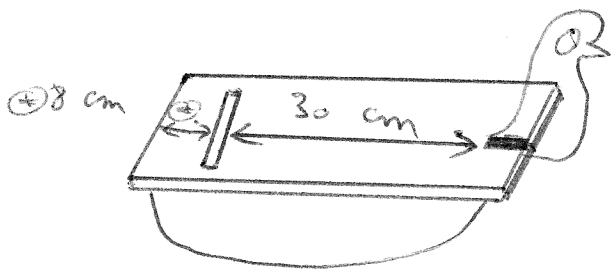

: Vue dessus

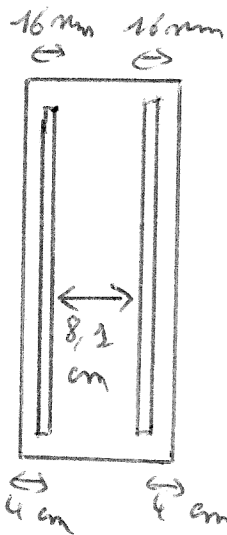

: Vue dessous

- Fixations par des squelettes de chair en métal.
- Pas possible par vis ça le médium se fad!
- Toutes les planches ont la même épaisseur
↳ 16 mm
- Âge enfant: 12 à 24 mois

VERSION FINALE (?)

(2)

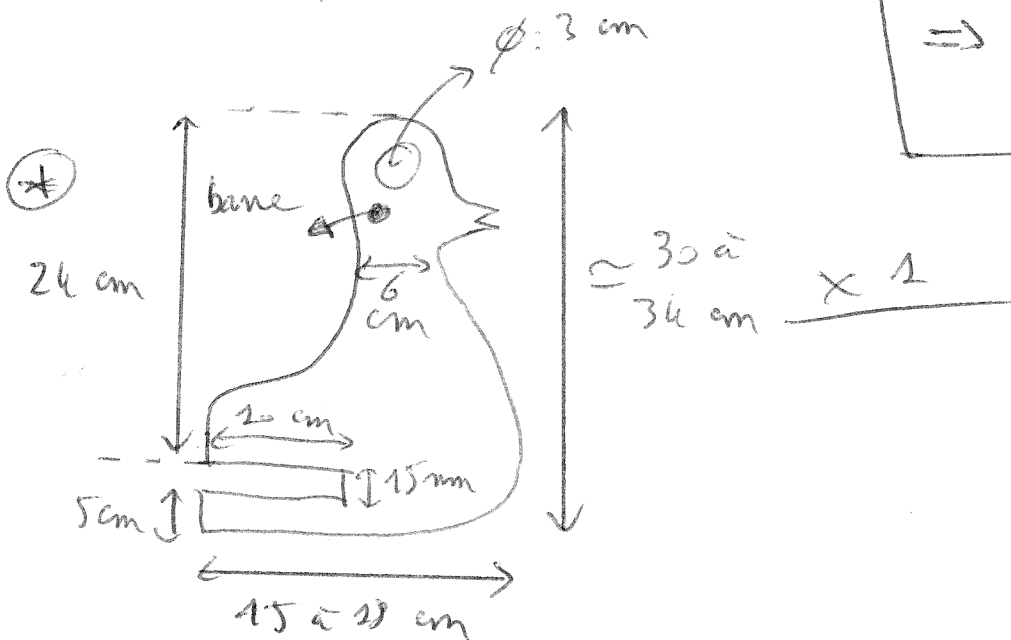
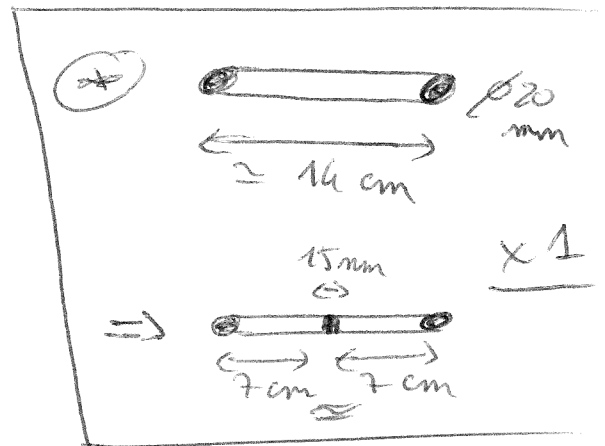
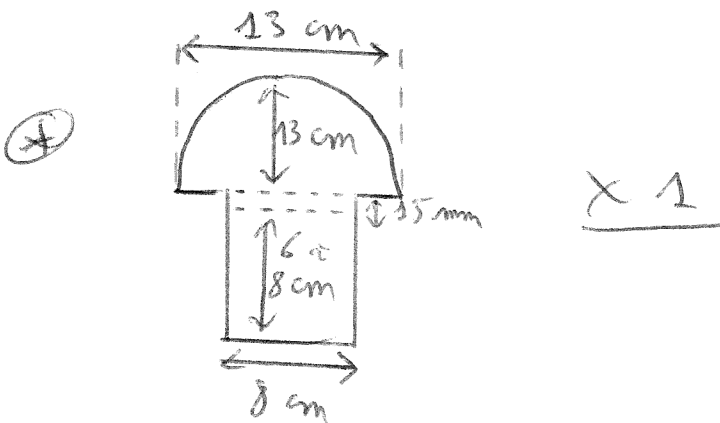
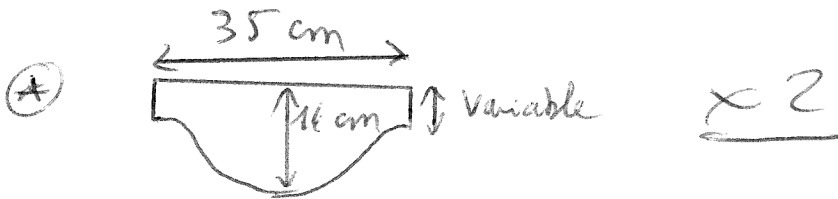
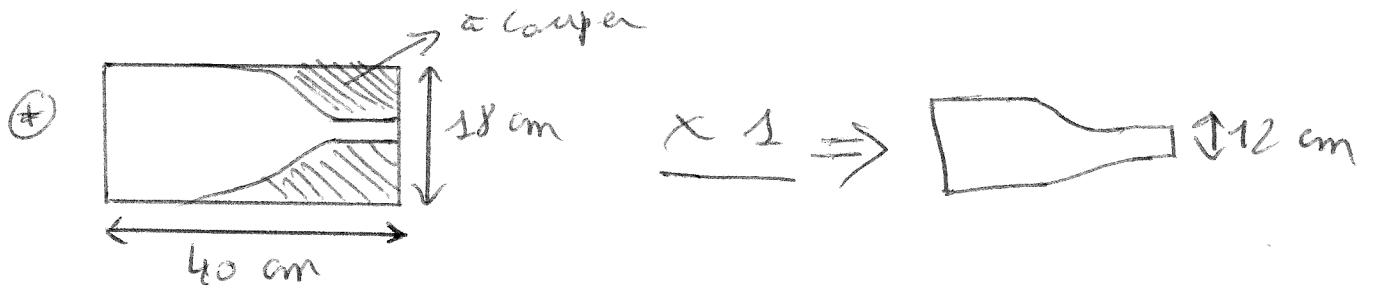

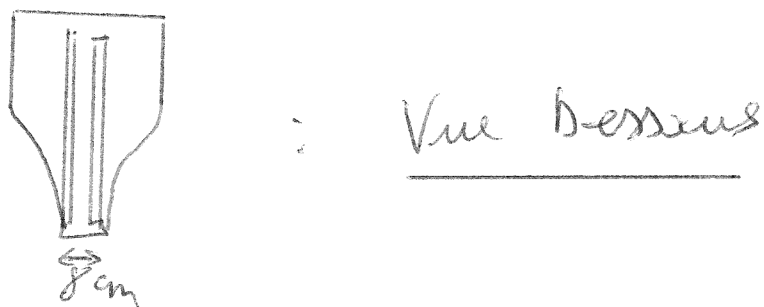
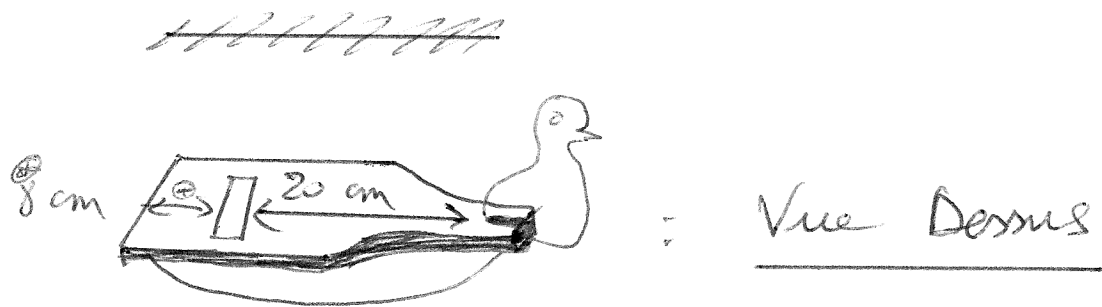

- Fixations par des équerres de chaise en métal : T caudées



- Toutes les planches ont la même épaisseur
↳ 15 mm
- Âge enfant : 12 à 24 mois
- ⚠ à l'anodi des cauds pour un effet de bascule + au - marqué.